

HSD2.55S

Submersible Slurry Pumps

OPERATION MANUAL

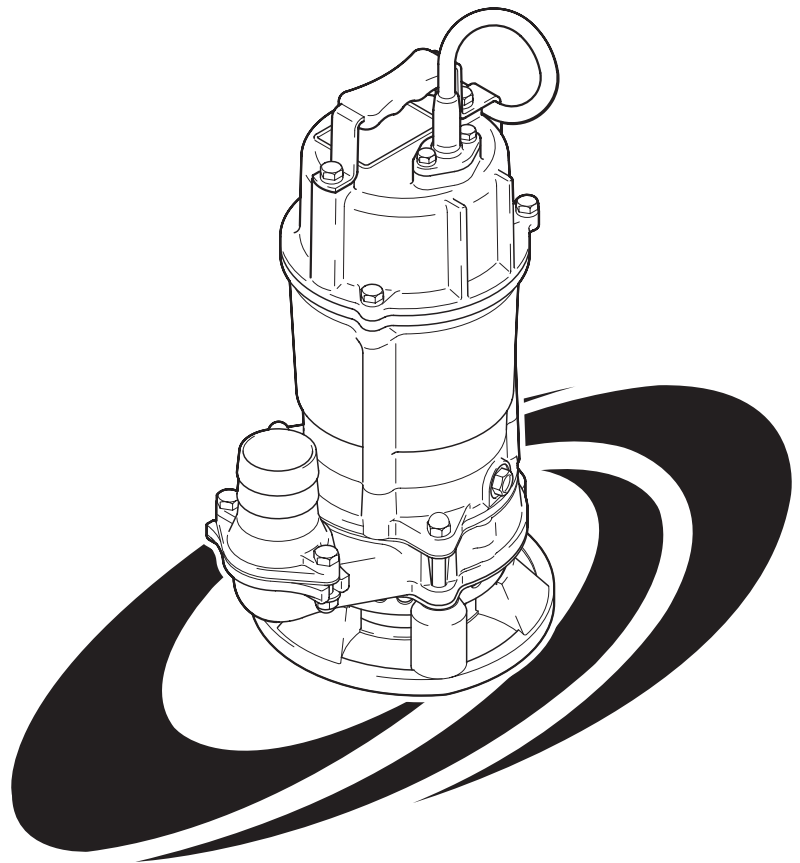

TSURUMI MANUFACTURING CO., LTD.

INTRODUCTION

Thank you for selecting the Tsurumi HSD submersible slurry pumps.

This manual explains how to use the HSD pump and gives instructions on precautions to take during use. In order to understand the features of the product and to use it in the most effective manner, be sure to read this manual and understand its contents before using the product.

This equipment should not be used for applications other than those listed in this manual. Failure to observe this precaution may lead to a malfunction or an accident. In the event of a malfunction or an accident, the manufacture will not assume any liability. After reading this operation manual, keep it in a location that is easily accessible, so that it can be referred to whenever information is needed.

In case this equipment is lent to another party, be sure to also lend this operation manual together with the equipment.

If this operation manual becomes lost or damaged, contact the dealer where the equipment was purchased, or the Tsurumi sales office in your area.

This manual was prepared with the utmost attention to detail. However, if any errors or omissions are encountered, contact the dealer from whom this unit was purchased, or the Tsurumi sales office in your area.

The contents of this manual may not be copied in whole or in part without consent of Tsurumi Manufacturing Company, Limited.

CONTENTS

1. BE SURE TO READ FOR YOUR SAFETY.....	2	Connecting the Power Plug	9
Precautions to the Product Specifications ..	2	About the Power Cable.....	9
Precautions During Transport and		Motor Circuit Diagram.....	10
Installation.....	2	Motor Protector	10
Precautions During Test Operation and		6. OPERATION	10
Operation	3	Prior to Operation	10
Precautions During Maintenance and		Trial Operation	11
Inspection	4	Operation	11
Precaution to Power Outage.....	4	Operating Water Level.....	11
Other Precaution.....	4	7. MAINTENANCE AND INSPECTION.....	12
2. PART NAMES	5	Prior to Inspection.....	12
3. PRIOR TO OPERATION	5	Daily and Periodic Inspection	12
Inspecting the Product.....	5	Storage	12
Inspecting the Specification.....	5	Oil Inspection and Changing Procedures ...	13
Inspecting the Accessories	6	Replacement Parts	13
Product Specifications	6	8. DISASSEMBLY AND	
4. INSTALLATION	6	REASSEMBLY PROCEDURE	13
Preparation for Installation.....	7	Disassembly Procedure.....	14
Precautions During Installation	7	Disassembly Diagram.....	14
5. ELECTRICAL WIRING.....	8	Reassembly Procedure	14
Electrical Wiring Work.....	8	9. TROUBLESHOOTING	15
Grounding	8	Disposal of Product.....	15

1 BE SURE TO READ FOR YOUR SAFETY

Be sure to thoroughly read and understand the SAFETY PRECAUTIONS given in this section before using the equipment in order to operate the equipment correctly.

The precautionary measures described in this section are intended to prevent danger or damage to you or to others. The contents of this manual that could possibly be performed improperly are classified into two categories: **⚠ WARNING**, and **⚠ CAUTION**. The categories indicate the extent of possible damage or the urgency of the precaution. Note however, that what is included under **⚠ CAUTION** may at times lead to a more serious problem. In either case, the categories pertain to safety-related items, and as such, must be observed carefully.

- **⚠ WARNING** : Operating the equipment improperly by failing to observe this precaution may possibly lead to death or injury to humans.
- **⚠ CAUTION** : Operating the equipment improperly by failing to observe this precaution may possibly cause injury to humans and other physical damage.
- **NOTE** : Gives information that does not fall in the WARNING or CAUTION categories.
- **Explanation of Symbols:**



: The \triangle mark indicates a WARNING or CAUTION item. The symbol inside the mark describes the precaution in more detail ("electrical shock", in the case of the example on the left).



: The \circ mark indicates a prohibited action. The symbol inside the mark, or a notation in the vicinity of the mark describes the precaution in more detail ("disassembly prohibited", in the case of the example on the left).



: The \bullet mark indicates an action that must be taken, or instructs how to perform a task. The symbol inside the mark describes the precaution in more detail ("provide ground work", in the case of the example on the left).

PRECAUTIONS TO THE PRODUCT SPECIFICATIONS

⚠ CAUTION











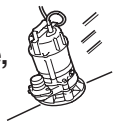
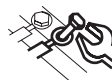
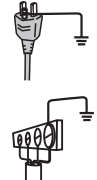









● Do not operate the product under any conditions other than those for which it is specified. **Failure to observe the precaution can lead to electrical leakage, electrical shock, fire, water overflow or other problems.**





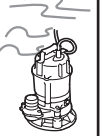

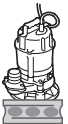











PRECAUTIONS DURING TRANSPORT AND INSTALLATION



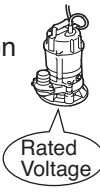

⚠ WARNING

	<p>● When transporting the product, pay close attention to its center of gravity and mass. Use an appropriate lifting equipment to lift the unit. Improper lifting may result in the fall of the product which could cause damage of the product or human injury.</p> 		<p>● Install the product properly in accordance with this instruction manual. Improper installation may result in electrical leakage, electrical shock, fire, water leakage, or injury.</p> 
	<p>● Electrical wiring should be performed in accordance with all applicable regulations in your country. Absolutely provide a dedicated earth leakage circuit breaker and a thermal overload relay suitable for the product (available on the market). Imperfect wiring or improper protective equipment can lead to electrical leakage, fire, or explosion in the worst case.</p> 		<p>● Provide a secure grounding dedicated for the product. Never fail to provide an earth leakage circuit breaker and a thermal overload relay in your starter or control panel (Both available on the market). If an electrical leakage occurs by due to a product failure, it may cause electrical shock.</p> 
	<p>● Use a power outlet that has a sufficient rating and has been exclusively provided for the pump. If the power outlet is shared with other equipment, it can lead to an abnormal heat of the outlet and can cause fire as a result.</p>		<p>Power Supply Capacity</p> 





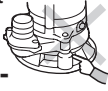

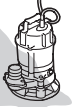

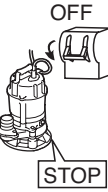

 CAUTION			
	<p>● Be sure to provide a ground wire securely. Do not connect the ground wire to a gas pipe, water pipe, lightning rod, or telephone ground wire. Improper grounding could cause electrical shock.</p> 		<p>● Attach a hose securely to the hose coupling. Imperfect connection of hose could cause water leakage which may result in the damage of nearby walls, floors, and other equipment.</p> 
	<p>● Do not scratch, fold, twist, make alterations, or bundle the cable, or use it as a lifting device. The cable may be damaged, which may cause electrical leakage, short-circuit, electrical shock, or fire.</p> 		<p>● Do not use the cable if it is damaged or it is not closely fitted. Connect every conductor of the cable securely to the terminals. Failure to observe this can lead to electrical shock, short-circuit, or fire.</p> 
	<p>● Use the handle when installing or carrying the pump. Never use the cable to carry or to suspend. Doing so may damage the cable which could cause electrical leakage, short circuit, or fire.</p> 		<p>● This pump is neither dust-proof nor explosion-proof. Do not use it at a dusty place or at a place where toxic, corrosive or explosive gas is present. Use in such places could cause fire or explosion.</p> 
	<p>● Allow the pump to suck as few foreign objects as possible. If there is a risk that the pump could be buried under the sediment, place it on a solid base like concrete block.</p> 		<p>● If a hose is used for the discharge line, take a measure to prevent the hose from shaking. If the hose shakes, you may be wet or injured.</p> 

PRECAUTIONS DURING TEST OPERATION AND OPERATION



 WARNING			
	<p>● Never try to operate the pump if somebody is present in the pump sump. If an electrical leakage occurs, it can cause electrical shock.</p> 		<p>● Never start the pump while it is suspended, as the unit may jerk and could lead to injury.</p> 
	<p>● When changing power connection is needed to correct the direction of rotation, be sure to turn off the power supply (earth leakage circuit breaker, etc.), and perform the work after making sure that the impeller has stopped completely. Failure to do so may lead to electrical shock, short-circuit, or injury.</p> 		<p>● When inspecting the pump, be sure to turn off the power supply (earth leakage circuit breaker, etc.) so that the pump may not start accidentally. Failure to do so may lead to a serious accident.</p> 
 CAUTION			
	<p>● Do not operate the product under any voltage other than described on the nameplate with the voltage variation limit within $\pm 10\%$. If it is operated with a generator, it is strongly suggested not to operate other equipment with the same generator. Failure to observe this caution may cause malfunction and breakdown of the product, which may lead to electrical leakage or electrical shock.</p> 		<p>● Do not touch the product with bare hands during or immediate after the operation, as the product may become very hot during operation. Failure to observe this caution may lead to be burned.</p> 
	<p>● Do not use the product in a liquid other than water. Use in oil, salt water or organic solvents will damage it, which may lead to electrical leakage or electrical shock.</p> 		<p>● Do not use the product for hot or warm liquid over 40°C, as doing so will damage the product, which may lead to electrical leakage or electrical shock.</p> 

 CAUTION	
 <ul style="list-style-type: none"> Do not allow foreign object (pin, wire, etc.) to enter the suction inlet of the pump. Failure to observe this caution could cause it to malfunction or to operate abnormally, which may lead to electrical leakage or electrical shock. 	<ul style="list-style-type: none"> When the product will not be used for an extended period, be sure to turn off the power supply (earth leakage circuit breaker, etc.). Deterioration of the insulation may lead to electrical leakage, electrical shock, or fire.   



PRECAUTIONS DURING MAINTENANCE AND INSPECTION

 WARNING	
 <ul style="list-style-type: none"> Absolutely turn off the power supply or disconnect the plug before starting maintenance or inspection. Do not work with wet hands. Failure to observe these cautions may lead to electrical shock or injury. 	<ul style="list-style-type: none"> Do not disassemble or repair any parts other than those designated in the operation manual. If repairs are necessary in any other than the designated parts, consult with the dealer where it was purchased or Tsurumi representative. Improper repairs can result in electrical leakage, electrical shock, fire, or water leakage. 
 <ul style="list-style-type: none"> In case any abnormality (excessive vibration, unusual noise or odor) is found in the operation, turn the power off immediately and consult with the dealer where it was purchased or Tsurumi representative. Continuing to operate the product under abnormal conditions may result in electrical shock, fire, or water leakage. 	
 CAUTION	
 <ul style="list-style-type: none"> After reassembly, always perform a test operation before resuming use of the product. Improper assembly can result in electrical leakage, electrical shock, fire, or water leakage. 	

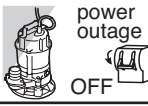
PRECAUTION TO POWER OUTAGE

 WARNING	
 <ul style="list-style-type: none"> In case of power outage, turn off the power supply. The product will resume operation when the power is restored, which presents serious danger to people in the vicinity. 	

OTHER PRECAUTION

 CAUTION	
 <ul style="list-style-type: none"> Never use the product for potable water. It may present a danger to human health. 	

2 PART NAMES

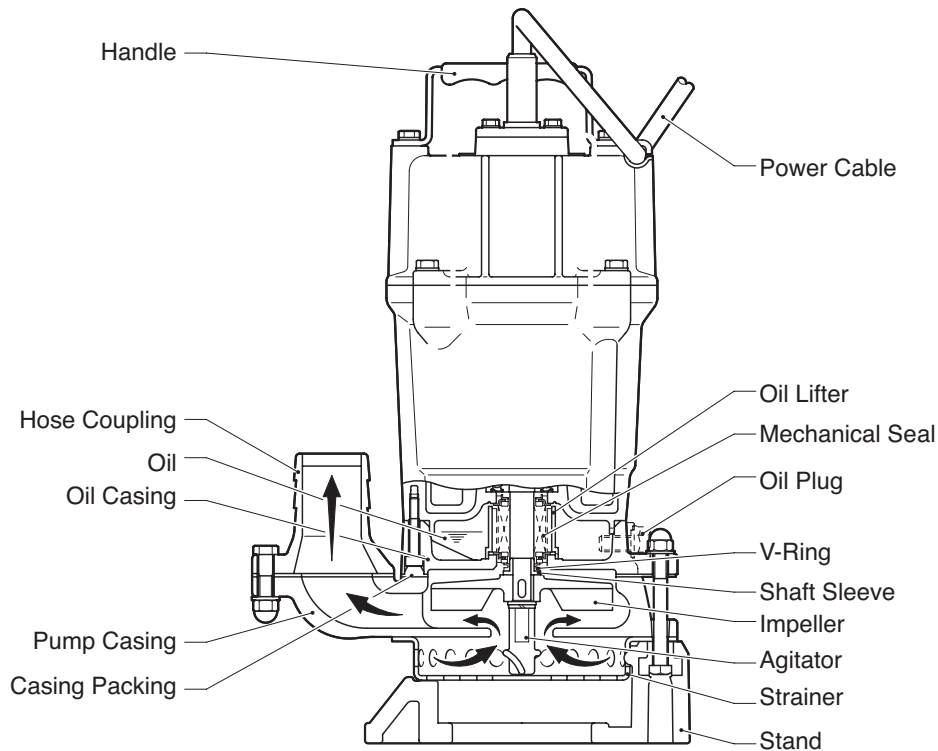

3 PRIOR TO OPERATION

Unpack the package and check the following points:

Inspecting the product

Verify that no damage has occurred to the unit during shipment and that the bolts and nuts have not loosened.

Inspecting the Specification

Check the nameplate of the product to verify that it is the product that you have ordered. Pay particular attention to its voltage and frequency specifications.

Example of nameplate

TSURUMI PUMP		SUBMERSIBLE PUMP <small>(Built in motor protector)</small>	
No.	③	①	②
MODEL	④	⑤	Hz
H MAX.	⑥	m	H MIN.
⑦	m	⑧	DN
⊕ Q MAX.	⑧	m ³ /min	⑨
⊕	mm	⊕	
U	⑩	~	⑪
	V		
I	⑫		A
P ₂	⑬	kW	INS.
⑭	T MAX.	⑮	°C
Wt	⑯	kg	N
⑰	min ⁻¹	IP	⑱
	m		
TSURUMI MFG.CO.,LTD.			
Side View		Top View	
⬇ ROTATION		⤵ ROTATION	
		XXXXX	

1	Submersible pump	11	Rated voltage
2	Built in motor protector	12	Rated current
3	Serial number	13	Rated output power
4	Model	14	Insulation class
5	Frequency	15	Max. liquid temperature
6	Max. total head	16	Weight without cable
7	Min. total head	17	Speed of rotation
8	Max. flow rate	18	IP degree of protection
9	Discharge bore	19	Max. immersion depth
10	Phase	20	Direction of rotation

Note: If you discover any damage or discrepancy, please contact with the Tsurumi dealer from whom you purchased the product or the nearest Tsurumi representative office.

Inspecting the Accessories

Verify that all accessory items are included in the package.

- Wire Hose Band 1 No.
- Operation Manual 1 copy

Note: *If you discover any damage or discrepancy in the product, please contact the dealer where this equipment was purchased or the Tsurumi sales office in your area.*

Product Specifications

CAUTION Never use the product under conditions other than those that are specified in the product specification, as they may lead to current leakage, electrical shock, fire, or water leakage.

Major Standard Specifications

Fluid	Property	Water, Sand Carrying Water, Muddy Water, Slurry Water; 0 ~ 40°C
Pump	Impeller	Semi-vortex type
	Shaft Seal	Double Mechanical Seal
	Bearing	Shielded Ball Bearing
Motor	Type, Poles	Dry type Submersible Induction Motor, 2-Pole
	Class of Insulation	Class E
	Motor Protection (built-in)	Circle thermal protector
Lubricant		Turbine Oil, ISO VG32 (non-additive)
Discharge Connection		Hose Coupling

Major Standard specifications (50/60Hz)

Bore Size (mm) (inch)	Model	Motor Output (kW) (HP)	Power Supply	Max.Head (m) (Ft)	Max.Flow Rate (m ³ /min) (GPM)	Mass (kg) (Lbs)	Max.Solid Passage (mm) (inch)	Std.Cable Length (m) (Ft)
50 2	HSD2.55S	0.55 3/4	1-phase	13.2 43	0.22 58	14 31	9 11/32	5 16

Note: *The weight shows the weight of pump unit excluding the power cable.*

4 INSTALLATION

CAUTION

- Do not use the pump for pumping liquids other than plain water, such as oil, salt water, or organic solvents.
- Use with a power supply voltage variation within $\pm 10\%$ of the rated voltage.
- The water temperature for operating the pump should be between 0 ~ 40°C. Failure to observe the precautions given above could cause the pump to malfunction, which may lead to current leakage or electrical shock.

Note: *To use the pump for a special solution, contact the dealer where it was purchased, or the Tsurumi sales office in your area.*

Critical Use Pressure

CAUTION Do not operate the pump in an area that is exposed to a water pressure that exceeds the values given below.

Critical Use Pressure	0.2MPa (2kgf/cm ²) - discharge pressure during use
-----------------------	--

Preparation for Installation

Listed below are tools and instruments that are needed to install the submersible pump for general dewatering purpose.



AC voltmeter
(tester)

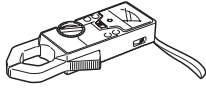

AC ammeter
(clamp)

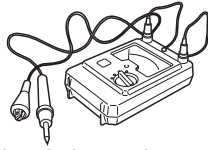

Insulation resistance
tester
(megger tester)

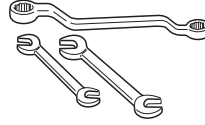

Wrenches for
fastening
bolts and nuts

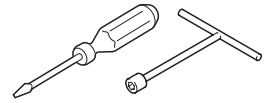

Wrenches for connecting
the power supply
(a screwdriver or a box wrench)

Single-phase power supply:

Use a megger to measure the resistance between the tip of the cable plug and the ground terminal to verify the insulation resistance of the motor.

Measure twice the resistance between each of the two tips of plug and ground.

(This diagram shows a 3-pin plug type.)

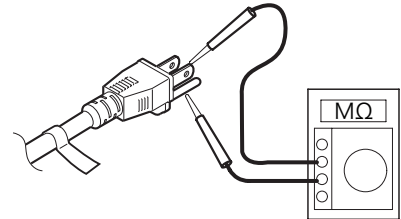

CAUTION Beware that the power plug varies by country or region.

Insulation resistance reference value = 20M Ω minimum

Note: *The insulation resistance reference value of 20M Ω minimum is based on a new or repaired pump. For reference values of a pump that has already been put into operation, refer to "7. Maintenance and Inspection" of this manual.*

Precautions During Installation

WARNING When installing the pump, be mindful of the pump's center of gravity and weight. If the pump is not suspended properly, the pump may fall and break, which may lead to injury.

CAUTION When installing or moving the pump, never suspend the pump by the cabletyre cable. Doing so will damage the cable, which may cause a current leakage, electrical shock, or fire.

- (1) When a hose is used, attach the hose to the hose coupling as far as it will go, then fasten it securely with a hose band.

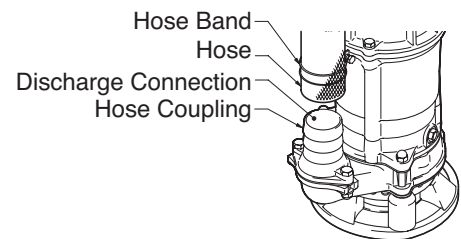

- (2) Handle the pump carefully without applying shock to it, such as by dropping it. To suspend the pump, do so manually or by attaching a rope or chain to its handles.

CAUTION The rope for suspending the pump during its installation must be of a thickness that accommodates the weight of the pump. When using a chain, make sure that the chain does not become twisted. Failure to observe these precautions could cause the rope or chain to break and the pump to fall and break, which could lead to personal injury.

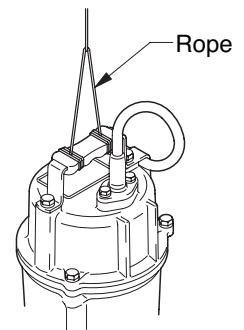

(3) Operate the pump in a location that has a sufficient water level and collects water easily.

Note: For the water level required for operating the pump, refer to the external dimension drawing, which is provided separately.

Extend the end of the hose (discharge side) above the water surface. If the end of the hose is submerged in water, it may cause the water to flow back when the pump has been stopped. Conversely, if the end of the hose is located at a level that is lower than the source water surface, water may continue to flow out even after the pump has been stopped.

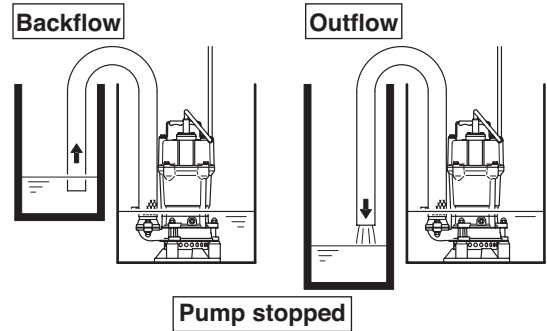

CAUTION If the pump draws in a large amount of mud, it could cause the pump to wear prematurely and lead to a malfunction, current leakage, and electrical shock.

(4) Route the hose as straight as possible. Excessive bending of the hose could obstruct the flow of water, reduce the pumping volume, or clog the pump with mud, thus disabling the pumping function. If the hose is kinked at its base, it will create air pockets in the pump, making the pump operate dry. To prevent this from occurring, straighten the bend while operating the pump.

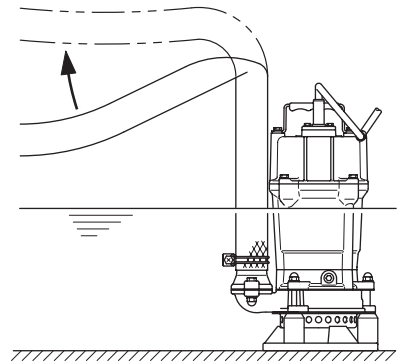

CAUTION If the pump draws in a large amount of mud, it could cause the pump to wear prematurely and lead to a malfunction, current leakage, and electrical shock.

(5) Operate the pump upright. If there is the likelihood of the pump drawing in excess mud, place a concrete block under the pump.

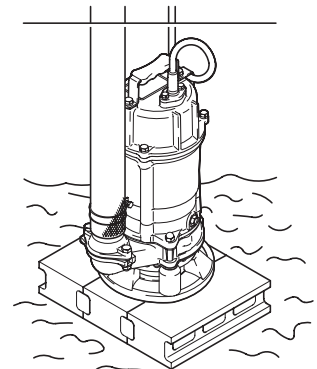

5 ELECTRICAL WIRING

Electrical Wiring Work

WARNING • All electrical work must be performed by an authorized electrician, in compliance with local electrical equipment standards and internal wiring codes. Never allow an unauthorized person to perform electrical work because it is not only against the law, but it can also be extremely dangerous.

- Improper wiring can lead to current leakage, electrical shock, or fire.
- Absolutely provide a dedicated earth leakage circuit breaker and a thermal overload relay suitable for the pump (available on the market). Failure to follow this warning can cause electrical shock or explosion when the product fails or an electrical leakage occurs.

Operate well within the capacity of the power supply and wiring.

Grounding

WARNING Be sure to install the ground wire securely. Failure to observe this precaution could damage the pump and cause current leakage, which may lead to electrical shock.

CAUTION Do not connect the ground wire to a gas pipe, water pipe, lightning rod, or telephone ground wire. Improper grounding could cause electrical shock.

Connecting the Power Plug

WARNING Before inserting the power plug or connecting the wires to the terminal board, make sure that the power supply (i.e. circuit breaker) is properly disconnected. Failure to do so may lead to electrical shock, short, or injury caused by the unintended starting of the pump.

CAUTION Do not use damaged cable cables, power plugs, or loose power outlets. Failure to observe this precaution could lead to electrical shock, short circuit, or fire.

Follow the diagram on the right to connect the power.

When using a three-prong grounded plug, connect as shown in the drawing.

CAUTION Be sure to use a dedicated power supply with a ground leakage circuit breaker.

(This diagram shows a 3-pin plug type.)

CAUTION Beware that the power plug varies by country or region.

Note: *The shape of the plug may differ from that shown in the illustration.*

When a single-phase power source is used, connect the leads to the control panel terminals as shown in the diagram, making sure they do not become twisted together.

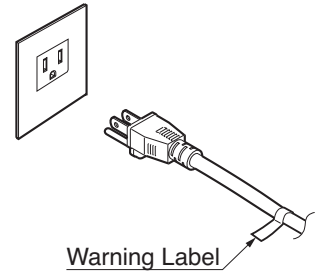
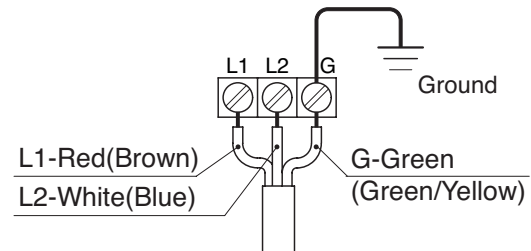

About the Power Cable

- CAUTION**
- If it is necessary to extend the power cable, use a core size equal to or larger than the original. This is necessary not only for avoiding a performance drop, but to prevent cable overheating which can result in fire, electrical leakage or electrical shock.
 - If a cable with cut insulation or other damage is submerged in the water, there is a danger of water incursion into the motor causing a short. This may result in damage of the product, electrical leakage, electrical shock, or fire.
 - Be careful not to let the cable be cut or become twisted. This may result in damage to the product, electrical leakage, electrical shock, or fire.
 - If it is necessary to submerge the connected part into the water, first seal the leads completely in a molded protected sleeve, to prevent electrical leakage, electrical shock or fire.



Do not submerge the end of the power cable into water.

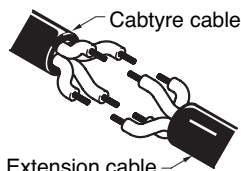

If it is necessary to extend the power cable, use a core size equal to or larger than the original.



If it is necessary to submerge the connected part into the water, seal the part completely.



Make sure the cable does not become excessively bent or twisted, and does not rub against a structure in a way that might damage it.

Motor Circuit Diagram

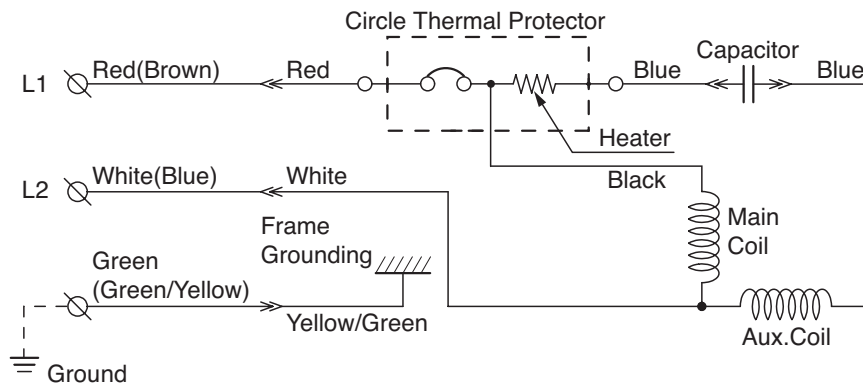

Motor Protector

The pump is equipped with a built-in motor protector (circle thermal protector).

If a current overload or overheating occurs under the symptoms given below, the pump will stop automatically to protect the motor regardless of the water level at the time of operation.

- Extreme fluctuation of power supply voltage
- Pump operated under overload condition
- Pump operated at open phase or binding condition

Note: After the motor protector has tripped, the motor automatically resumes its operation. Therefore, make sure to disconnect the cable from the terminal board or the power outlet, and eliminate the cause of the problem.

Do not operate the pump at unusually low head, or with the impeller clogged with debris. Doing so will not only prevent the pump from attaining its full potential, but may also generate abnormal noise and vibration and damage the pump.

6 OPERATION

Prior to Operation

- (1) Once again, check the nameplate of the pump to verify that its voltage and frequency are correct.

CAUTION Improper voltage and frequency of the power supply will prevent the pump from attaining its full potential, and may also damage the pump.

Note: Verify the specs on the pump's nameplate.

- (2) Check the wiring, power supply voltage, the capacity of the ground leakage circuit breaker, and the insulation resistance of the motor.

■ Insulation resistance reference value = 20MΩ minimum

Note: The insulation resistance reference value of 20MΩ minimum is based on a new or repaired pump. For reference values of a pump that has already been put into operation, refer to "Maintenance and Inspection".

- (3) Adjust the setting of the thermal relay (i.e. 3E relay) to the pump's rated current.

Note: Verify the rated current on the pump's nameplate.

- (4) When using a generator, as much as possible avoid operating the pump in conjunction with other types of equipment.

Trial Operation

WARNING Never start the pump while it is suspended, as the pump may jerk and cause a serious accident involving injury.

(1) Operate the pump for a short time (3-10 minutes) and verify its operating conditions.

CAUTION If the pump generates a considerable amount of vibration, noise, or smell, disconnect the power supply immediately and contact the dealer where the pump purchased, or the Tsurumi sales office in your area. If the pump is continued to be used in the abnormal state, it may cause current leakage, electrical shock, or fire.

(2) Continue operation if no abnormal conditions are found during the trial operation.

Operation

WARNING The pump unit may be extremely hot during operation. To prevent burns, do not touch the pump unit with bare hands during or after an operation.

Pay attention to the water level during the pump operation. The pump may become damaged if it is allowed to operate dry.

Due to an overload operation or a pump malfunction, if the motor protector trips to stop the pump, make sure to eliminate the cause of the problem before restarting.

Note: A large amount of amperage flows when a submersible pump is started, causing the temperature of its windings to rise rapidly. Beware that a frequent stop-and-go operation of the pump will accelerate the deterioration of the insulation of the motor windings, and thus affect the use life of the motor.

Use a clamp meter to measure the operating current.

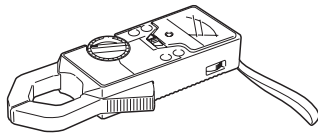

Check the power supply voltage to confirm if it is within the rated range.

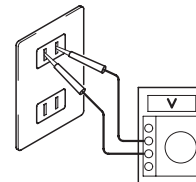

Operating Water Level

CAUTION Do not operate the pump below the C.W.L. (Continuous Running Water Level) indicated below. Failure to observe this condition may result in damage to the pump, electrical leakage or electrical shock.

Pump Model	C.W.L. (mm)
HSD2.55S	105

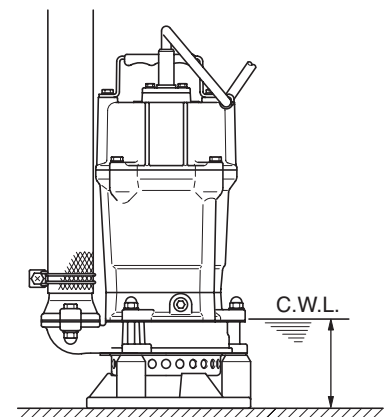

7 MAINTENANCE AND INSPECTION

Regular maintenance and inspection are indispensable to maintaining the pump's performance. If the pump behaves differently from its normal operating condition, refer to section "9. Troubleshooting" and take appropriate measures at an early stage. We also recommend that you have a spare pump on hand for an emergency.

Prior to Inspection

WARNING Make sure that the power supply (i.e. circuit breaker) is disconnected and disconnect the cable from the power outlet or remove it from the terminal board. Failure to do so may cause electrical shock or unintended starting of the pump, which may lead to serious accidents.

- (1) Washing the Pump
Remove any debris attached to the pump's outer surface, and wash the pump with tap water. Pay particular attention to the impeller area, and completely remove any debris from the impeller.
- (2) Inspecting the Pump Exterior
Verify that there is no damage, and that the bolts and nuts have not loosened.

Note: If the pump must be disassembled for repair due to damage or loose bolts or nuts, contact the dealer where it was purchased, or the Tsurumi sales office in your area.

Daily and Periodic Inspection

Interval	Inspection Item
Daily	Measuring the operating current ■ To be below the rated current Measuring the power voltage ■ Power supply voltage variation = within $\pm 10\%$ of the rated voltage
Monthly	Measuring the insulation resistance ■ Insulation resistance reference value = 1M Ω minimum [NOTE] The motor must be inspected if the insulation resistance is considerably lower than the last inspection. Pump inspection ■ A noticeable drop in performance may indicate wear in the impeller, etc., or else clogging of the strainer stand, etc. Remove the clogged debris, and replace any worn parts.
Semi-yearly	Inspecting oil ■ 1,000 hours or 6 months, whichever comes first. Inspection of lifting rope or chain ■ Replace if damage, corrosion, or wear has occurred to the rope or the chain. Remove if foreign object is attaching to it.
Yearly	Changing oil ■ 2,000 hours or 12 months, whichever comes first. Changing the mechanical seal [NOTE] The inspection and replacement of the mechanical seal requires specialized equipment. To have this operation performed, contact the dealer where this equipment was purchased, or the Tsurumi sales office in your area.
Once every 2 to 5 years	Overhaul ■ The pump must be overhauled even if the pump appears normal during operation. Especially, the pump may need to be overhauled earlier if it is used continuously. [NOTE] To overhaul the pump, contact the dealer where it was purchased, or the Tsurumi sales office in your area.

Note: Refer to section "Oil Inspection and Change Procedures" below for further detail.

Storage

If the pump will not be operated for a long period of time, pull the pump up, wash the pump, allow it to dry, and store it indoors.

Note: For reinstallation, be sure to perform a trial operation before putting the pump into operation.

If the pump remains immersed in water, operate it on a regular basis (i.e. once a week).

Oil Inspection and Changing Procedures

WARNING When the pump is tilted for inspecting or changing the oil, pay careful attention to the center of gravity and weight of the pump. When lowering the pump, fasten the wire rope or the chain to the eyebolts provided for this purpose. Failing to lower the pump completely may result in damage or injury if the pump is dropped.

Inspecting Oil

Remove the oil plug and take out a small amount of oil. The oil can be extracted easily by tilting the pump so that the oil filler plug faces downward. If the oil appears milky or intermixed with water, a likely cause is a defective shaft sealing device (i.e. mechanical seal), which requires that the pump be disassembled and repaired.

Changing Oil

Remove the oil plug and drain the oil completely. Pour a specified volume of oil into the oil filler inlet.

Specified Oil: Turbine Oil VG32 (non-additive)
Specified Volume: 160 ml

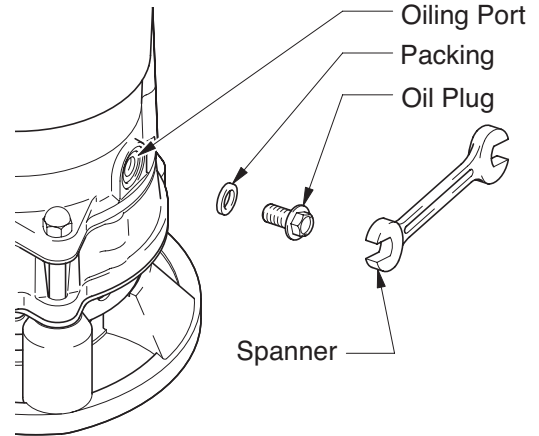

Note: The drained oil must be disposed of properly to prevent it from being released into the sewer or rivers. The packing or the O-ring for the oil plug must be replaced with a new part at each oil inspection and change.

Replacement Parts

The table lists the parts that need to be replaced periodically. Replace these using the recommended frequency as a guideline.

Part	Replacement condition
Mechanical Seal	When oil in oil compartment becomes milky.
Lubricant ; Turbine Oil VG 32 (non-additive)	Every 12 months or after 2,000 hours of use, whichever comes first.
Packing, O-Ring	Each time pump is disassembled or inspected
V-Ring	When ring is worn, and each time pump is disassembled or inspected
Shaft sleeve	When it becomes worn

8 DISASSEMBLY AND REASSEMBLY PROCEDURE

■ Prior to Disassembly and Reassembly



WARNING Before disassembling and reassembling the pump, be sure that the power supply (i.e. circuit breaker) is disconnected, and remove the cabtyre cable from the outlet or the terminal board. Do not connect or disconnect the power plug with a wet hand, in order to prevent electrical shock. Do not perform an activation test (to check the rotation of the impeller) during disassembly and reassembly. Failure to observe this precaution could lead to a serious accident, including injury.

This section explains the disassembly and reassembly processes that are involved up to the replacement of the impeller itself. Operations involving the disassembly and reassembly of the sealing portion (i.e. mechanical seal) and of the motor require a specialized facility including vacuum and electrical test equipment. For these operations, contact the dealer where this equipment was purchased, or the Tsurumi sales office in your area.

Disassembly Procedure

Note: For assembly or disassembly, place the pump on its side.

Remove the Hex.Bolts(1) and Hex.Nuts(2), then remove the Stand, Strainer and Pump Casing.

Disassembly Diagram

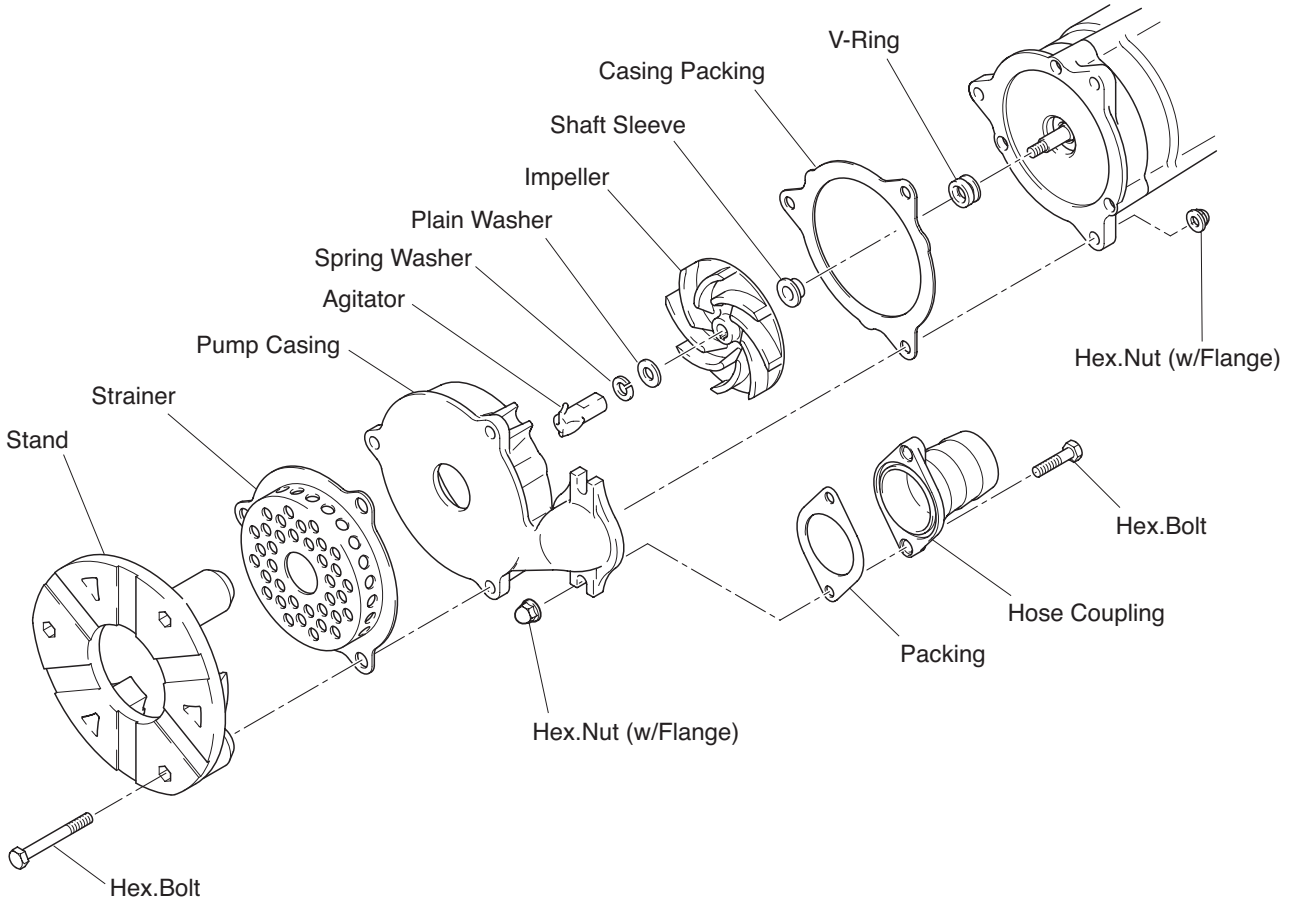

Reassembly Procedure

Reassembly can be performed by reversing the steps for disassembly.

- (1) Remove sand and other debris from rubber parts such as the Impeller and casing Packing before assembling the pump.
- (2) Make sure the Casing Packing fits snugly against the Oil Casing.
- (3) When tightening the agitator, do not apply excessive force that might deform the impeller or cause the rubber liner to flake off.

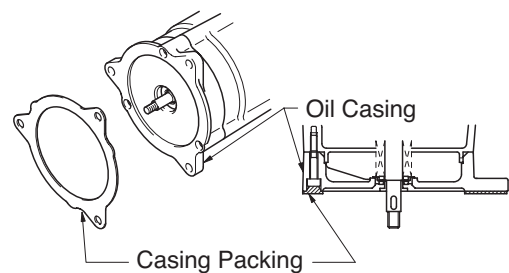
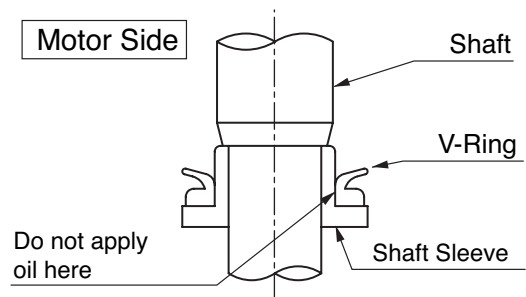

9 TROUBLESHOOTING

⚠ WARNING To prevent serious accidents, disconnect the power supply before inspecting the pump.

Read this Operation Manual carefully before requesting repair. After re-inspecting the pump, if it does not operate normally, contact the dealer where this equipment was purchased, or the Tsurumi sales office in your area.

Problem	Possible cause	Countermeasure
Pump fails to start; or, starts but stops immediately.	(1)No proper power is supplied (i.e. power outage). (2)Open circuit in cabtyre cable or poor connection. (3)Open circuit in cabtyre cable or poor connection.	(1>Contact the electric power company or an electrical repair shop. (2)Check whether there is an open circuit in the cabtyre cable or wiring. (3)Check whether there is an open circuit in the cabtyre cable or wiring.
Pump starts but stops immediately, causing the motor protector to trip.	(1)Foreign matter is wedged in the impeller, causing the motor protector to trip. (2)The voltage is too low. (3)A 50Hz unit is used at 60Hz. (4)The pump has been operated for a long time with its strainer stand clogged. (5)Malfunction of motor (seizure or water leakage). (6)The pump is drawing in too much mud.	(1)Inspect the pump and remove the debris. (2)Provide the rated voltage or use an extension cable that meets the specifications. (3)Check the nameplate and replace the pump. (4)Remove the debris from the strainer stand. (5)Repair or replace. (6)Place a concrete block under the pump to prevent the pump from drawing in excess mud.
The pumping volume is low.	(1)The impeller is worn. (2)The hose is clogged or kinked at its midspan. (3)The strainer stand is clogged or is buried. (4)The motor rotates in reverse. (5)A 60Hz pump is used at 50Hz.	(1)Replace the impeller. (2)Minimize the bends of the hose, and if the pump is used in a dusty area, place it inside a mesh basket during operation. (3)Remove the debris from the strainer stand. Place a concrete block under the pump to prevent the pump from drawing in excess mud. (4)Change the power connection. (5)Check the nameplate and replace the pump.
Pump generates vibration or noise.	(1)Motor bearings are damaged.	(1)Replace the bearings.

The following information is required when ordering repairs or making other inquiries.

Product model	
Manufacturing number	
Purchase date	
Remarks	

Disposal of Product

Properly dispose of the product by disassembling it, presorting the contents, and sending them to the waste material treatment site.